



PULEGGE DENTATE PER CINGHIE HTD®

HTD® TIMING BELT PULLEYS

3M

PASSO 3 mm

PER CINGHIE LARGHEZZA 9 mm

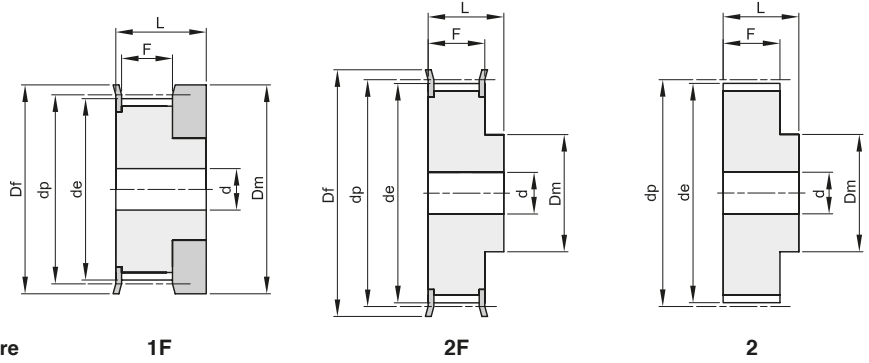

Materiale: Alluminio UNI 9006 - T6 (Al)
adatto per l'ossidazione dura a spessore

descrizione	codice	tipo	materiale	denti	dp	de	Df	Dm	Di	F	L	d	n° flangia	Kg.
10 3M 09	40009010	1F	Al	10	9,55	8,79	13,0	12,0		10,2	17,5		100	0,01
12 3M 09	40009012	1F	Al	12	11,46	10,70	15,0	15,0		10,2	17,5		101	0,01
14 3M 09	40009014	1F	Al	14	13,37	12,61	16,0	16,0		10,2	17,5		102	0,01
15 3M 09	40009015	1F	Al	15	14,32	13,56	18,0	17,5		10,2	17,5		104	0,01
16 3M 09	40009016	2F	Al	16	15,28	14,52	18,0	10,0		12,8	20,6	4	104	0,01
18 3M 09	40009018	2F	Al	18	17,19	16,43	19,5	11,0		12,8	20,6	6	105	0,01
20 3M 09	40009020	2F	Al	20	19,10	18,34	23,0	13,0		12,8	20,6	6	107	0,01
21 3M 09	40009021	2F	Al	21	20,05	19,29	25,0	14,0		12,8	20,6	6	108	0,01
22 3M 09	40009022	2F	Al	22	21,01	20,25	25,0	14,0		12,8	20,6	6	108	0,01
24 3M 09	40009024	2F	Al	24	22,92	22,16	25,0	14,0		12,8	20,6	6	108	0,02
26 3M 09	40009026	2F	Al	26	24,83	24,07	28,0	16,0		12,8	20,6	6	109	0,02
28 3M 09	40009028	2F	Al	28	26,74	25,98	32,0	18,0		12,8	20,6	6	110	0,02
30 3M 09	40009030	2F	Al	30	28,65	27,89	32,0	20,0		12,8	20,6	6	110	0,03
32 3M 09	40009032	2F	Al	32	30,56	29,80	36,0	22,0		12,8	20,6	6	111	0,03
36 3M 09	40009036	2F	Al	36	34,38	33,62	38,0	26,0		13,4	22,2	6	112	0,05
40 3M 09	40009040	2F	Al	40	38,20	37,44	42,0	28,0		13,4	22,2	6	113	0,06
44 3M 09	40009044	2F	Al	44	42,02	41,26	48,0	33,0		13,4	22,2	6	114	0,07
48 3M 09	40009048	2	Al	48	45,84	45,08		33,0		13,4	22,2	8		0,11
60 3M 09	40009060	2	Al	60	57,30	56,54		33,0		13,4	22,2	8		0,11
72 3M 09	40009072	2	Al	72	68,76	68,00		33,0		13,4	22,2	8		0,15



PULEGGE DENTATE PER CINGHIE HTD®

HTD® TIMING BELT PULLEYS

3M

PASSO 3 mm

PER CINGHIE LARGHEZZA 15 mm

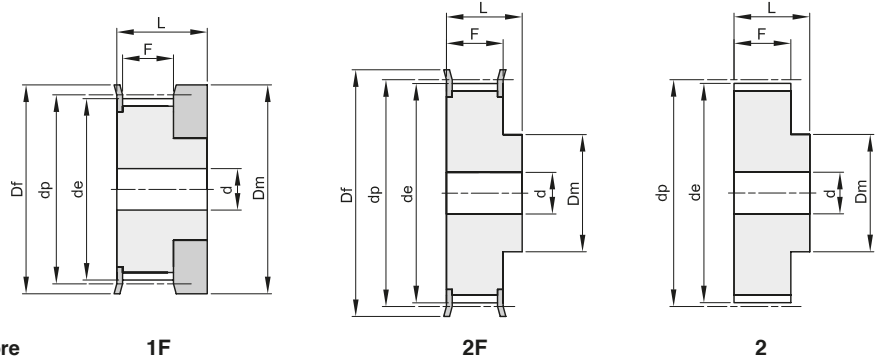

Materiale: Alluminio UNI 9006 - T6 (Al)
adatto per l'ossidazione dura a spessore

descrizione	codice	tipo	materiale	denti	dp	de	Df	Dm	Di	F	L	d	n° flangia	Kg.
10 3M 15	40015010	1F	Al	10	9,55	8,79	13,0	12,0		17,0	26,0		100	0,01
12 3M 15	40015012	1F	Al	12	11,46	10,70	15,0	15,0		17,0	26,0		101	0,01
14 3M 15	40015014	1F	Al	14	13,37	12,61	16,0	16,0		17,0	26,0		102	0,01
15 3M 15	40015015	1F	Al	15	14,32	13,56	18,0	17,5		17,0	26,0		104	0,01
16 3M 15	40015016	2F	Al	16	15,28	14,52	18,0	10,0		19,5	26,0	4	104	0,01
18 3M 15	40015018	2F	Al	18	17,19	16,43	19,5	11,0		19,5	26,0	6	105	0,01
20 3M 15	40015020	2F	Al	20	19,10	18,34	23,0	13,0		19,5	26,0	6	107	0,01
21 3M 15	40015021	2F	Al	21	20,05	19,29	25,0	14,0		19,5	26,0	6	108	0,02
22 3M 15	40015022	2F	Al	22	21,01	20,25	25,0	14,0		19,5	26,0	6	108	0,02
24 3M 15	40015024	2F	Al	24	22,92	22,16	25,0	14,0		19,5	26,0	6	108	0,02
26 3M 15	40015026	2F	Al	26	24,83	24,07	28,0	16,0		19,5	26,0	6	109	0,03
28 3M 15	40015028	2F	Al	28	26,74	25,98	32,0	18,0		19,5	26,0	6	110	0,03
30 3M 15	40015030	2F	Al	30	28,65	27,89	32,0	20,0		19,5	26,0	6	110	0,04
32 3M 15	40015032	2F	Al	32	30,56	29,80	36,0	22,0		19,5	26,0	6	111	0,04
36 3M 15	40015036	2F	Al	36	34,38	33,62	38,0	26,0		20,0	30,0	6	112	0,06
40 3M 15	40015040	2F	Al	40	38,20	37,44	42,0	28,0		20,0	30,0	6	113	0,08
44 3M 15	40015044	2F	Al	44	42,02	41,26	48,0	33,0		20,0	30,0	6	114	0,10
48 3M 15	40015048	2	Al	48	45,84	45,08		33,0		20,0	30,0	8		0,10
60 3M 15	40015060	2	Al	60	57,30	56,54		33,0		20,0	30,0	8		0,15
72 3M 15	40015072	2	Al	72	68,76	68,00		33,0		20,0	30,0	8		0,21



PULEGGE DENTATE PER CINGHIE HTD®

HTD® TIMING BELT PULLEYS

5M

PASSO 5 mm

PER CINGHIE LARGHEZZA 9 mm

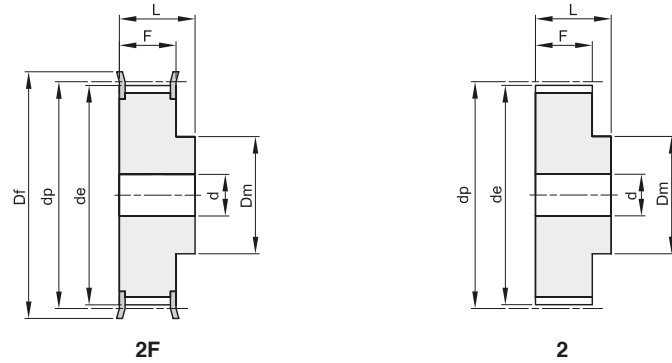

Materiale: Acciaio (St)
 Materiale: Alluminio UNI 9006 - T6 (Al)
 adatto per l'ossidazione dura a spessore

descrizione	codice	tipo	materiale	denti	dp	de	Df	Dm	Di	F	L	d	n° flangia	Kg.
12 5M 09	41009012	2F	St	12	19,10	17,96	23	12,5		14,5	20,0	6	202	0,03
14 5M 09	41009014	2F	St	14	22,28	21,14	25	13,5		14,5	20,0	6	203	0,04
15 5M 09	41009015	2F	St	15	23,87	22,73	28	16,0		14,5	20,0	6	204	0,05
16 5M 09	41009016	2F	St	16	25,46	24,32	28	16,5		14,5	20,0	6	204	0,05
18 5M 09	41009018	2F	St	18	28,65	27,51	32	20,0		14,5	20,0	6	205	0,07
20 5M 09	41009020	2F	St	20	31,83	30,69	36	23,0		14,5	22,5	6	206	0,10
21 5M 09	41009021	2F	St	21	33,42	32,28	38	24,0		14,5	22,5	6	207	0,12
22 5M 09	41009022	2F	St	22	35,01	33,87	38	25,5		14,5	22,5	6	207	0,13
24 5M 09	41009024	2F	St	24	38,20	37,06	42	27,0		14,5	22,5	6	208	0,15
26 5M 09	41009026	2F	St	26	41,38	40,24	44	30,0		14,5	22,5	6	209	0,18
28 5M 09	41009028	2F	St	28	44,56	43,42	48	30,5		14,5	22,5	6	210	0,21
30 5M 09	41009030	2F	St	30	47,75	46,60	51	35,0		14,5	22,5	6	211	0,25
32 5M 09	41009032	2F	St	32	50,93	49,79	54	38,0		14,5	22,5	8	212	0,28
36 5M 09	41009036	2F	St	36	57,30	56,16	60	38,0		14,5	22,5	8	214	0,33
40 5M 09	41009040	2F	St	40	63,66	62,52	71	38,0		14,5	22,5	8	217	0,42
44 5M 09	41009044	2	Al	44	70,03	68,89		38,0		14,5	25,5	8		0,17
48 5M 09	41009048	2	Al	48	76,39	75,25		45,0		14,5	25,5	8		0,18
60 5M 09	41009060	2	Al	60	95,49	94,35		45,0		14,5	25,5	8		0,23
72 5M 09	41009072	2	Al	72	114,59	113,45		45,0		14,5	25,5	8		0,42



PULEGGE DENTATE PER CINGHIE HTD®

HTD® TIMING BELT PULLEYS

5M

PASSO 5 mm

PER CINGHIE LARGHEZZA 15 mm

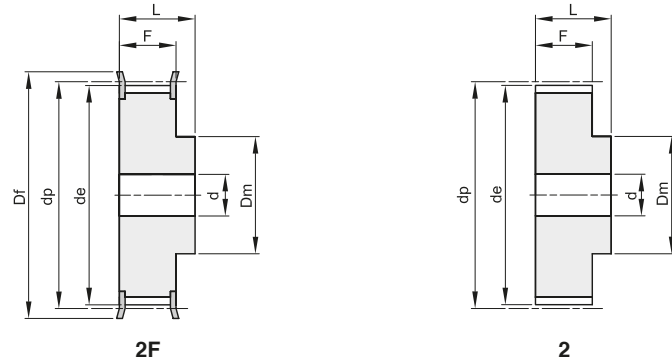

Materiale: Acciaio (St)
 Materiale: Alluminio UNI 9006 - T6 (Al)
 adatto per l'ossidazione dura a spessore

descrizione	codice	tipo	materiale	denti	dp	de	Df	Dm	Di	F	L	d	n° flangia	Kg.
12 5M 15	41015012	2F	St	12	19,10	17,96	23	12,5		20,5	26	6	202	0,03
14 5M 15	41015014	2F	St	14	22,28	21,14	25	13,5		20,5	26	6	203	0,04
15 5M 15	41015015	2F	St	15	23,87	22,73	28	16,0		20,5	26	6	204	0,05
16 5M 15	41015016	2F	St	16	25,46	24,32	28	16,5		20,5	26	6	204	0,06
18 5M 15	41015018	2F	St	18	28,65	27,51	32	20,0		20,5	26	6	205	0,09
20 5M 15	41015020	2F	St	20	31,83	30,69	36	23,0		20,5	26	6	206	0,12
21 5M 15	41015021	2F	St	21	33,42	32,28	38	24,0		20,5	26	6	207	0,14
22 5M 15	41015022	2F	St	22	35,01	33,87	38	25,5		20,5	26	6	207	0,15
24 5M 15	41015024	2F	St	24	38,20	37,06	42	27,0		20,5	28	6	208	0,19
26 5M 15	41015026	2F	St	26	41,38	40,24	44	30,0		20,5	28	6	209	0,23
28 5M 15	41015028	2F	St	28	44,56	43,42	48	30,5		20,5	28	6	210	0,26
30 5M 15	41015030	2F	St	30	47,75	46,60	51	35,0		20,5	28	6	211	0,32
32 5M 15	41015032	2F	St	32	50,93	49,79	54	38,0		20,5	28	8	212	0,35
36 5M 15	41015036	2F	St	36	57,30	56,16	60	38,0		20,5	28	8	214	0,43
40 5M 15	41015040	2F	St	40	63,66	62,52	71	38,0		20,5	28	8	217	0,52
44 5M 15	41015044	2	Al	44	70,03	68,89		38,0		20,5	30	8		0,23
48 5M 15	41015048	2	Al	48	76,39	75,25		38,0		20,5	30	8		0,29
60 5M 15	41015060	2	Al	60	95,49	94,35		50,0		20,5	30	8		0,42
72 5M 15	41015072	2	Al	72	114,59	113,45		50,0		20,5	30	8		0,59



PULEGGE DENTATE PER CINGHIE HTD®

HTD® TIMING BELT PULLEYS

5M

PASSO 5 mm

PER CINGHIE LARGHEZZA 25 mm

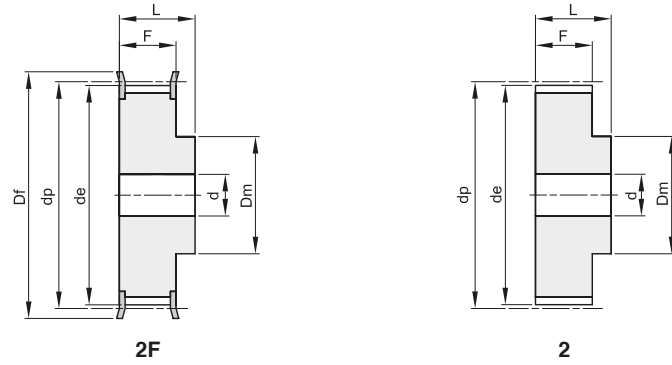

Materiale: Acciaio (St)
 Materiale: Alluminio UNI 9006 - T6 (Al)
 adatto per l'ossidazione dura a spessore

descrizione	codice	tipo	materiale	denti	dp	de	Df	Dm	Di	F	L	d	n° flangia	Kg.
12 5M 25	41025012	2F	St	12	19,10	17,96	23	12,5		30,5	36	6	202	0,05
14 5M 25	41025014	2F	St	14	22,28	21,14	25	13,5		30,5	36	6	203	0,08
15 5M 25	41025015	2F	St	15	23,87	22,73	28	16,0		30,5	36	6	204	0,09
16 5M 25	41025016	2F	St	16	25,46	24,32	28	16,5		30,5	36	6	204	0,11
18 5M 25	41025018	2F	St	18	28,65	27,51	32	20,0		30,5	36	6	205	0,13
20 5M 25	41025020	2F	St	20	31,83	30,69	36	23,0		30,5	36	6	206	0,17
21 5M 25	41025021	2F	St	21	33,42	32,28	38	24,0		30,5	38	6	207	0,20
22 5M 25	41025022	2F	St	22	35,01	33,87	38	25,5		30,5	38	6	207	0,22
24 5M 25	41025024	2F	St	24	38,20	37,06	42	27,0		30,5	38	6	208	0,26
26 5M 25	41025026	2F	St	26	41,38	40,24	44	30,0		30,5	38	6	209	0,32
28 5M 25	41025028	2F	St	28	44,56	43,42	48	30,5		30,5	38	6	210	0,37
30 5M 25	41025030	2F	St	30	47,75	46,60	51	35,0		30,5	38	6	211	0,42
32 5M 25	41025032	2F	St	32	50,93	49,79	54	38,0		30,5	38	8	212	0,48
36 5M 25	41025036	2F	St	36	57,30	56,16	60	38,0		30,5	38	8	214	0,59
40 5M 25	41025040	2F	St	40	63,66	62,52	71	38,0		30,5	38	8	217	0,75
44 5M 25	41025044	2	Al	44	70,03	68,89		38,0		30,5	40	8		0,32
48 5M 25	41025048	2	Al	48	76,39	75,25		38,0		30,5	40	8		0,28
60 5M 25	41025060	2	Al	60	95,49	94,35		50,0		30,5	40	8		0,44
72 5M 25	41025072	2	Al	72	114,59	113,45		50,0		30,5	40	8		0,85



PULEGGE DENTATE PER CINGHIE HTD®

HTD® TIMING BELT PULLEYS

8M

PASSO 8 mm

PER CINGHIE LARGHEZZA 20 mm

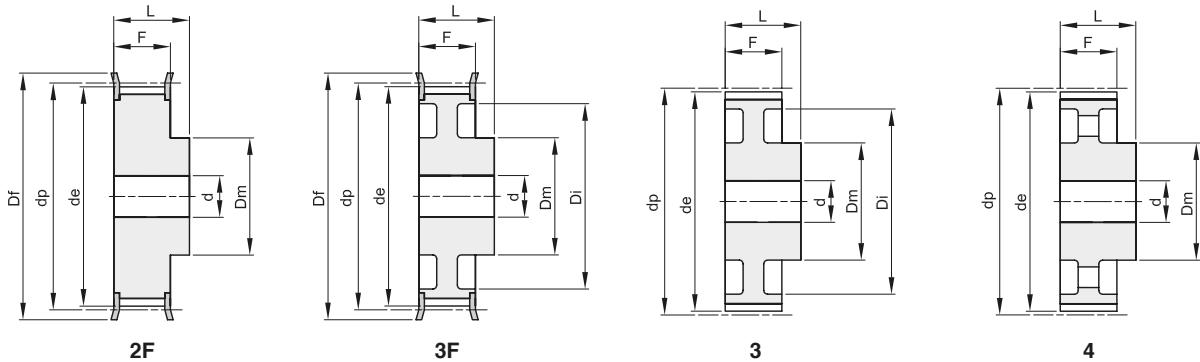

Materiale: Acciaio (St)
Materiale: Ghisa (GG)

descrizione	codice	tipo	materiale	denti	dp	de	Df	Dm	Di	F	L	d	n° flangia	Kg.
22 8M 20	42020022	2F	St	22	56,02	54,65	60	43		28	38	12	308	0,54
24 8M 20	42020024	2F	St	24	61,11	59,74	66	45		28	38	12	310	0,65
26 8M 20	42020026	2F	St	26	66,21	64,84	71	48		28	38	12	311	0,80
28 8M 20	42020028	2F	St	28	71,30	70,08	75	50		28	38	14	312	0,88
30 8M 20	42020030	2F	St	30	76,39	75,13	83	55		28	38	14	314	1,00
32 8M 20	42020032	2F	St	32	81,49	80,16	87	60		28	38	14	315	1,20
34 8M 20	42020034	2F	St	34	86,58	85,21	91	66		28	38	14	316	1,40
36 8M 20	42020036	2F	St	36	91,67	90,30	98	70		28	38	14	319	1,60
38 8M 20	42020038	2F	St	38	96,77	95,39	103	75		28	38	14	320	1,70
40 8M 20	42020040	2F	St	40	101,86	100,49	106	75		28	38	14	321	1,85
44 8M 20	42020044	2F	St	44	112,05	110,67	119	75		28	38	14	325	2,10
48 8M 20	42020048	2F	St	48	122,23	120,86	127	75		28	38	14	327	2,50
56 8M 20	42020056	3F	St	56	142,60	141,23	148	80	116	28	38	14	333	2,82
64 8M 20	42020064	3F	St	64	162,97	161,60	168	80	137	28	38	14	338	3,22
72 8M 20	42020072	3F	St	72	183,35	181,97	192	80	158	28	38	14	340	3,74
80 8M 20	42020080	3	GG	80	203,72	202,35		90	180	28	38	14		3,78
90 8M 20	42020090	3	GG	90	229,18	227,81		90	204	28	38	14		4,57
* 112 8M 20	42020112	4	GG	112	285,21	283,83		90	254	28	38	18		
* 144 8M 20	42020144	4	GG	144	366,69	365,32		90	336	28	38	20		
* 168 8M 20	42020168	4	GG	168	427,81	426,44		100	400	28	38	20		
* 192 8M 20	42020192	4	GG	192	488,92	487,55		100	460	28	38	20		

* Costruite a richiesta / Manufactured on request



PULEGGE DENTATE PER CINGHIE HTD®

HTD® TIMING BELT PULLEYS

8M

PASSO 8 mm

PER CINGHIE LARGHEZZA 30 mm

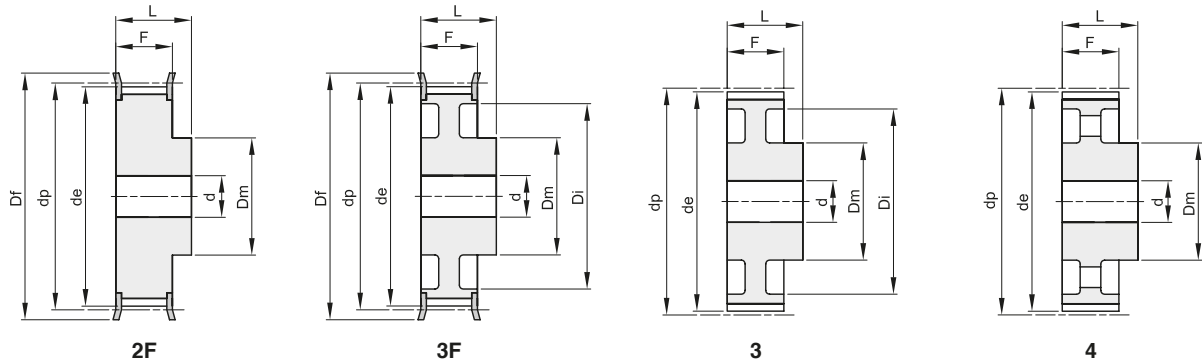

Materiale: Acciaio (St)
Materiale: Ghisa (GG)

descrizione	codice	tipo	materiale	denti	dp	de	Df	Dm	Di	F	L	d	n° flangia	Kg.
22 8M 30	42030022	2F	St	22	56,02	54,65	60	43		38	48	12	308	0,75
24 8M 30	42030024	2F	St	24	61,11	59,74	66	45		38	48	12	310	0,90
26 8M 30	42030026	2F	St	26	66,21	64,84	71	48		38	48	12	311	1,10
28 8M 30	42030028	2F	St	28	71,30	70,08	75	50		38	48	14	312	1,20
30 8M 30	42030030	2F	St	30	76,39	75,13	83	55		38	48	14	314	1,32
32 8M 30	42030032	2F	St	32	81,49	80,16	87	60		38	48	14	315	1,55
34 8M 30	42030034	2F	St	34	86,58	85,21	91	66		38	48	14	316	1,80
36 8M 30	42030036	2F	St	36	91,67	90,30	98	70		38	48	14	319	2,10
38 8M 30	42030038	2F	St	38	96,77	95,39	103	75		38	48	14	320	2,30
40 8M 30	42030040	2F	St	40	101,86	100,49	106	75		38	48	14	321	2,47
44 8M 30	42030044	2F	St	44	112,05	110,67	119	75		38	48	14	325	2,95
48 8M 30	42030048	2F	St	48	122,23	120,86	127	75		38	48	14	327	3,30
56 8M 30	42030056	3F	St	56	142,60	141,23	148	90	116	38	48	14	333	4,02
64 8M 30	42030064	3F	St	64	162,97	161,60	168	90	137	38	48	14	338	4,60
72 8M 30	42030072	3F	St	72	183,35	181,97	192	95	158	38	48	14	340	5,41
80 8M 30	42030080	3	GG	80	203,72	202,35		100	180	38	48	14		5,23
90 8M 30	42030090	3	GG	90	229,18	227,81		100	204	38	48	14		6,42
112 8M 30	42030112	4	GG	112	285,21	283,83		100	254	38	48	18		8,12
144 8M 30	42030144	4	GG	144	366,69	365,32		100	336	38	48	20		10,36
168 8M 30	42030168	4	GG	168	427,81	426,44		100	400	38	48	20		12,37
192 8M 30	42030192	4	GG	192	488,92	487,55		100	460	38	48	20		14,31



PULEGGE DENTATE PER CINGHIE HTD®

HTD® TIMING BELT PULLEYS

8M

PASSO 8 mm

PER CINGHIE LARGHEZZA 50 mm

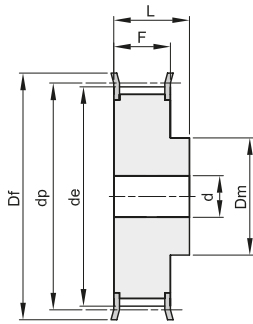

2F

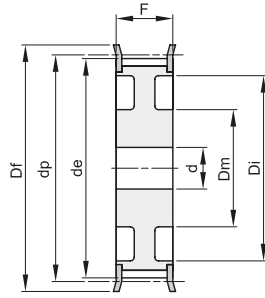

7F

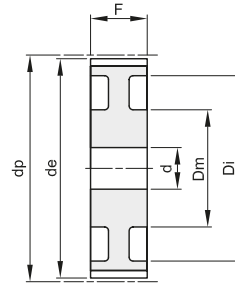

7

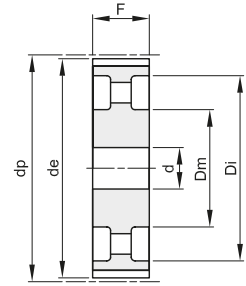

8

Materiale: Acciaio (St)
Materiale: Ghisa (GG)

descrizione	codice	tipo	materiale	denti	dp	de	Df	Dm	Di	F	L	d	n° flangia	Kg.
22 8M 50	42050022	2F	St	22	56,02	54,65	60	43		60	70	12	308	1,10
24 8M 50	42050024	2F	St	24	61,11	59,74	66	45		60	70	12	310	1,30
26 8M 50	42050026	2F	St	26	66,21	64,84	71	48		60	70	12	311	1,60
28 8M 50	42050028	2F	St	28	71,30	70,08	75	50		60	70	14	312	1,70
30 8M 50	42050030	2F	St	30	76,39	75,13	83	55		60	70	14	314	2,00
32 8M 50	42050032	2F	St	32	81,49	80,16	87	60		60	70	14	315	2,35
34 8M 50	42050034	2F	St	34	86,58	85,21	91	66		60	70	14	316	2,80
36 8M 50	42050036	2F	St	36	91,67	90,30	98	70		60	70	14	319	3,10
38 8M 50	42050038	2F	St	38	96,77	95,39	103	75		60	70	14	320	3,30
40 8M 50	42050040	2F	St	40	101,86	100,49	106	75		60	70	14	321	3,60
44 8M 50	42050044	2F	St	44	112,05	110,67	119	75		60	70	14	325	4,40
48 8M 50	42050048	2F	St	48	122,23	120,86	127	75		60	70	14	327	5,00
56 8M 50	42050056	7F	St	56	142,60	141,23	148	90	116	60	60	18	333	5,68
64 8M 50	42050064	7F	St	64	162,97	161,60	168	100	137	60	60	18	338	6,93
72 8M 50	42050072	7F	St	72	183,35	181,97	192	100	158	60	60	18	340	7,95
80 8M 50	42050080	7	GG	80	203,72	202,35		110	180	60	60	18		7,96
90 8M 50	42050090	7	GG	90	229,18	227,81		110	204	60	60	18		9,20
112 8M 50	42050112	8	GG	112	285,21	283,83		110	254	60	60	18		12,16
144 8M 50	42050144	8	GG	144	366,69	365,32		110	336	60	60	20		15,68
168 8M 50	42050168	8	GG	168	427,81	426,44		120	400	60	60	20		18,99
192 8M 50	42050192	8	GG	192	488,92	487,55		130	460	60	60	20		24,09



PULEGGE DENTATE PER CINGHIE HTD®

HTD® TIMING BELT PULLEYS

8M

PASSO 8 mm

PER CINGHIE LARGHEZZA 85 mm

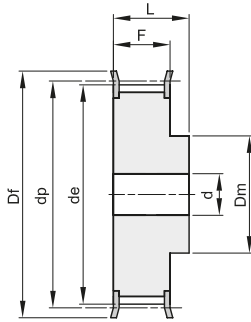

2F

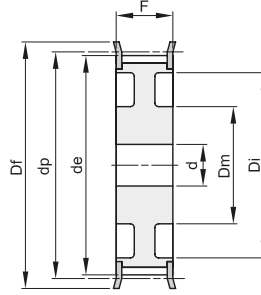

7F

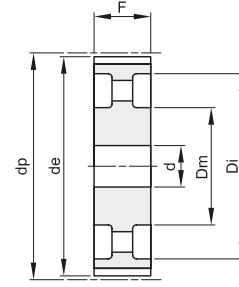

8

Materiale: Acciaio (St)
Materiale: Ghisa (GG)

descrizione	codice	tipo	materiale	denti	dp	de	Df	Dm	Di	F	L	d	n° flangia	Kg.
22 8M 85	42085022	2F	St	22	56,02	54,65	60	43		95	105	12	308	1,60
24 8M 85	42085024	2F	St	24	61,11	59,74	66	45		95	105	12	310	1,95
26 8M 85	42085026	2F	St	26	66,21	64,84	71	48		95	105	12	311	2,30
28 8M 85	42085028	2F	St	28	71,30	70,08	75	50		95	105	14	312	2,60
30 8M 85	42085030	2F	St	30	76,39	75,13	83	55		95	105	14	314	3,10
32 8M 85	42085032	2F	St	32	81,49	80,16	87	60		95	105	14	315	3,70
34 8M 85	42085034	2F	St	34	86,58	85,21	91	66		95	105	14	316	4,00
36 8M 85	42085036	2F	St	36	91,67	90,30	98	70		95	105	14	319	4,70
38 8M 85	42085038	2F	St	38	96,77	95,39	103	75		95	105	14	320	5,10
40 8M 85	42085040	2F	St	40	101,86	100,49	106	75		95	105	14	321	5,40
44 8M 85	42085044	2F	St	44	112,05	110,67	119	75		95	105	14	325	6,70
48 8M 85	42085048	2F	St	48	122,23	120,86	127	75		95	105	14	327	8,20
56 8M 85	42085056	2F	St	56	142,60	141,23	148	90		95	105	18	333	11,48
64 8M 85	42085064	7F	St	64	162,97	161,60	168	100	137	95	95	18	338	11,02
72 8M 85	42085072	7F	St	72	183,35	181,97	192	100	158	95	95	18	340	13,45
80 8M 85	42085080	8	GG	80	203,72	202,35		110	180	95	95	20		12,36
90 8M 85	42085090	8	GG	90	229,18	227,81		110	204	95	95	20		14,38
112 8M 85	42085112	8	GG	112	285,21	283,83		110	254	95	95	24		18,66
144 8M 85	42085144	8	GG	144	366,69	365,32		110	341	95	95	24		23,00
* 168 8M 85	42085168	8	GG	168	427,81	426,44		120	400	95	95	24		
* 192 8M 85	42085192	8	GG	192	488,92	487,55		130	460	95	95	24		

* Costruite a richiesta / Manufactured on request



PULEGGE DENTATE PER CINGHIE HTD®

HTD® TIMING BELT PULLEYS

14M

PASSO 14 mm

PER CINGHIE LARGHEZZA 40 mm

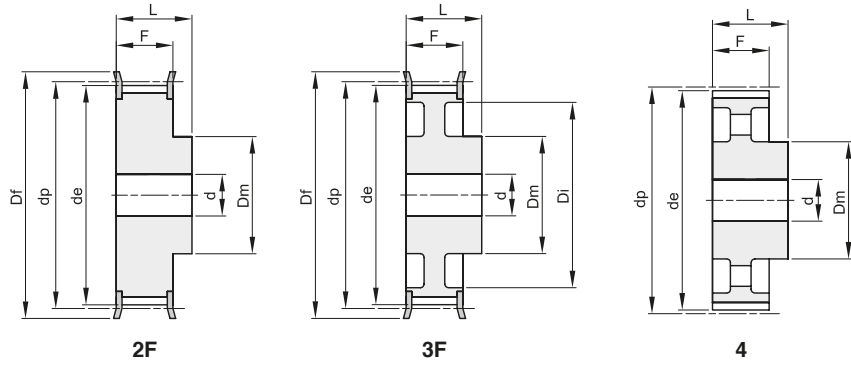

Materiale: Acciaio (St)
Materiale: Ghisa (GG)

descrizione	codice	tipo	materiale	denti	dp	de	Df	Dm	Di	F	L	d	n° flangia	Kg.
28 14M 40	43040028	2F	St	28	124,78	122,12	127	100		54	69	24	400	4,80
30 14M 40	43040030	2F	St	30	133,69	130,99	138	100		54	69	24	401	5,60
32 14M 40	43040032	2F	St	32	142,60	139,88	154	100		54	69	24	403	6,20
34 14M 40	43040034	2F	St	34	151,52	148,79	160	100		54	69	24	404	6,90
36 14M 40	43040036	2F	St	36	160,43	157,68	168	100		54	69	24	405	7,70
38 14M 40	43040038	2F	St	38	169,34	166,60	183	120		54	69	24	406	8,90
40 14M 40	43040040	2F	St	40	178,25	175,49	188	120		54	69	24	407	9,80
44 14M 40	43040044	2F	St	44	196,08	193,28	211	120		54	69	24	411	12,00
48 14M 40	43040048	3F	GG	48	213,90	211,11	226	135	170	54	69	24	412	11,98
56 14M 40	43040056	3F	GG	56	249,55	246,76	256	135	207	54	69	28	416	14,01
64 14M 40	43040064	3F	GG	64	285,21	282,41	296	135	240	54	69	28	418	16,65
72 14M 40	43040072	4	GG	72	320,86	318,06		135	278	54	69	28		15,52
80 14M 40	43040080	4	GG	80	356,51	353,71		135	314	54	69	28		17,23
90 14M 40	43040090	4	GG	90	401,07	398,28		135	358	54	69	28		19,40
112 14M 40	43040112	4	GG	112	499,11	496,32		135	456	54	69	28		24,14
* 144 14M 40	43040144	4	GG	144	641,71	638,92		135	600	54	69	28		
* 168 14M 40	43040168	4	GG	168	748,66	745,87		135	706	54	69	28		
* 192 14M 40	43040192	4	GG	192	855,62	852,82		135	813	54	69	28		

* Costruite a richiesta / Manufactured on request



PULEGGE DENTATE PER CINGHIE HTD®

HTD® TIMING BELT PULLEYS

14M

PASSO 14 mm

PER CINGHIE LARGHEZZA 55 mm

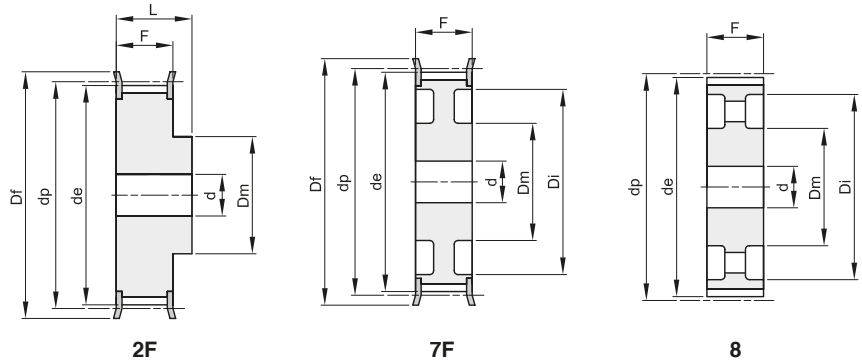

Materiale: Acciaio (St)
Materiale: Ghisa (GG)

descrizione	codice	tipo	materiale	denti	dp	de	Df	Dm	Di	F	L	d	n° flangia	Kg.
28 14M 55	43055028	2F	St	28	124,78	122,12	127	100		70	85	24	400	5,70
30 14M 55	43055030	2F	St	30	133,69	130,99	138	100		70	85	24	401	7,10
32 14M 55	43055032	2F	St	32	142,60	139,88	154	100		70	85	24	403	7,90
34 14M 55	43055034	2F	St	34	151,52	148,79	160	100		70	85	24	404	9,33
36 14M 55	43055036	2F	St	36	160,43	157,68	168	100		70	85	24	405	10,49
38 14M 55	43055038	2F	St	38	169,34	166,60	183	120		70	85	24	406	12,11
40 14M 55	43055040	2F	St	40	178,25	175,49	188	120		70	85	24	407	13,30
44 14M 55	43055044	2F	St	44	196,08	193,28	211	120		70	85	24	411	16,12
48 14M 55	43055048	7F	GG	48	213,90	211,11	226	135	170	70	70	24	412	13,50
56 14M 55	43055056	7F	GG	56	249,55	246,76	256	135	207	70	70	28	416	15,78
64 14M 55	43055064	7F	GG	64	285,21	282,41	296	135	240	70	70	28	418	19,04
72 14M 55	43055072	8	GG	72	320,86	318,06		135	278	70	70	28		18,41
80 14M 55	43055080	8	GG	80	356,51	353,71		135	314	70	70	28		20,27
90 14M 55	43055090	8	GG	90	401,07	398,28		135	358	70	70	28		22,98
112 14M 55	43055112	8	GG	112	499,11	496,32		135	456	70	70	28		29,29
144 14M 55	43055144	8	GG	144	641,71	638,92		135	600	70	70	28		36,00
168 14M 55	43055168	8	GG	168	748,66	745,87		135	706	70	70	28		40,00
192 14M 55	43055192	8	GG	192	855,62	852,82		135	813	70	70	28		47,50



PULEGGE DENTATE PER CINGHIE HTD®

HTD® TIMING BELT PULLEYS

14M

PASSO 14 mm

PER CINGHIE LARGHEZZA 85 mm

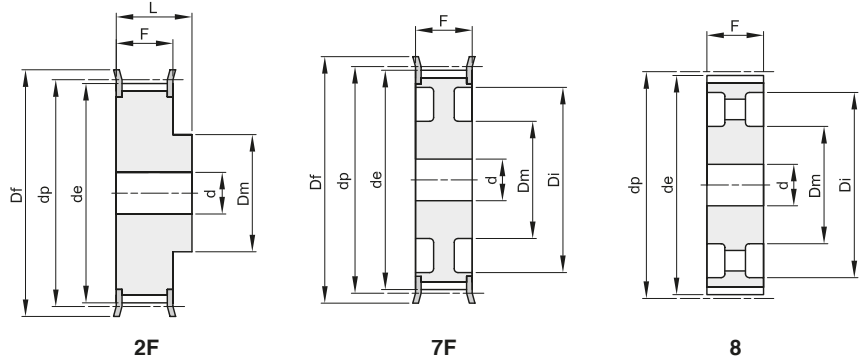

Materiale: Acciaio (St)
Materiale: Ghisa (GG)

descrizione	codice	tipo	materiale	denti	dp	de	Df	Dm	Di	F	L	d	n° flangia	Kg.
28 14M 85	43085028	2F	St	28	124,78	122,12	127	100		102	117	24	400	8,77
30 14M 85	43085030	2F	St	30	133,69	130,99	138	100		102	117	24	401	10,13
32 14M 85	43085032	2F	St	32	142,60	139,88	154	100		102	117	24	403	11,65
34 14M 85	43085034	2F	St	34	151,52	148,79	160	100		102	117	24	404	13,15
36 14M 85	43085036	2F	St	36	160,43	157,68	168	100		102	117	32	405	14,48
38 14M 85	43085038	2F	St	38	169,34	166,60	183	120		102	117	32	406	16,62
40 14M 85	43085040	2F	St	40	178,25	175,49	188	135		102	117	32	407	18,84
44 14M 85	43085044	2F	St	44	196,08	193,28	211	135		102	117	32	411	22,86
48 14M 85	43085048	2F	St	48	213,90	211,11	226	150		102	117	32	412	27,00
56 14M 85	43085056	7F	GG	56	249,55	246,76	256	150	207	102	102	32	416	24,19
64 14M 85	43085064	7F	GG	64	285,21	282,41	296	150	240	102	102	32	418	28,57
72 14M 85	43085072	8	GG	72	320,86	318,06		150	278	102	102	32		28,26
80 14M 85	43085080	8	GG	80	356,51	353,71		150	314	102	102	32		31,00
90 14M 85	43085090	8	GG	90	401,07	398,28		150	358	102	102	32		35,00
112 14M 85	43085112	8	GG	112	499,11	496,32		150	456	102	102	32		43,50
144 14M 85	43085144	8	GG	144	641,71	638,92		150	600	102	102	32		60,00
168 14M 85	43085168	8	GG	168	748,66	745,87		150	706	102	102	32		63,00
192 14M 85	43085192	8	GG	192	855,62	852,82		165	813	102	102	32		76,00



PULEGGE DENTATE PER CINGHIE HTD®

HTD® TIMING BELT PULLEYS

14M

PASSO 14 mm

PER CINGHIE LARGHEZZA 115 mm

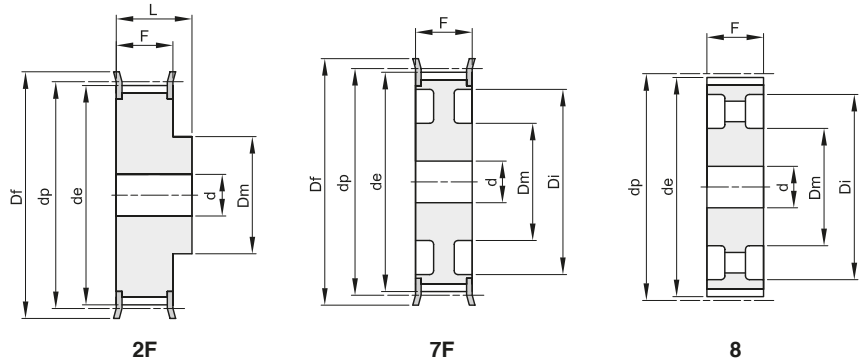

Materiale: Acciaio (St)
Materiale: Ghisa (GG)

descrizione	codice	tipo	materiale	denti	dp	de	Df	Dm	Di	F	L	d	n° flangia	Kg.
28 14M 115	43115028	2F	St	28	124,78	122,12	127	100		133	148	32	400	10,75
30 14M 115	43115030	2F	St	30	133,69	130,99	138	100		133	148	32	401	12,52
32 14M 115	43115032	2F	St	32	142,60	139,88	154	100		133	148	32	403	14,48
34 14M 115	43115034	2F	St	34	151,52	148,79	160	100		133	148	32	404	16,45
36 14M 115	43115036	2F	St	36	160,43	157,68	168	120		133	148	32	405	18,99
38 14M 115	43115038	2F	St	38	169,34	166,60	183	120		133	148	32	406	21,31
40 14M 115	43115040	2F	St	40	178,25	175,49	188	135		133	148	32	407	24,04
44 14M 115	43115044	2F	St	44	196,08	193,28	211	140		133	148	32	411	29,41
48 14M 115	43115048	2F	St	48	213,90	211,11	226	150		133	148	32	412	35,00
56 14M 115	43115056	2F	St	56	249,55	246,76	256	150		133	148	32	416	48,00
64 14M 115	43115064	7F	GG	64	285,21	282,41	296	150	240	133	133	32	418	36,00
72 14M 115	43115072	8	GG	72	320,86	318,06		150	278	133	133	32		36,00
80 14M 115	43115080	8	GG	80	356,51	353,71		150	314	133	133	32		40,00
90 14M 115	43115090	8	GG	90	401,07	398,28		150	358	133	133	32		45,00
112 14M 115	43115112	8	GG	112	499,11	496,32		150	456	133	133	32		55,50
144 14M 115	43115144	8	GG	144	641,71	638,92		165	600	133	133	32		71,00
168 14M 115	43115168	8	GG	168	748,66	745,87		165	706	133	133	32		83,00
192 14M 115	43115192	8	GG	192	855,62	852,82		165	813	133	133	32		96,00



PULEGGE DENTATE PER CINGHIE HTD®

HTD® TIMING BELT PULLEYS

14M

PASSO 14 mm

PER CINGHIE LARGHEZZA 170 mm

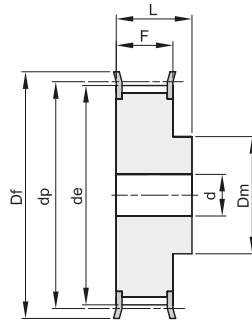

2F

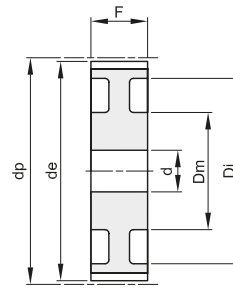

7

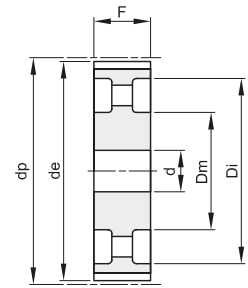

8

Materiale: Acciaio (St)
Materiale: Ghisa (GG)

descrizione	codice	tipo	materiale	denti	dp	de	Df	Dm	Di	F	L	d	n° flangia	Kg.
28 14M 170	43170028	2F	St	28	124,78	122,12	127	100		187	202	32	400	14,79
30 14M 170	43170030	2F	St	30	133,69	130,99	138	100		187	202	32	401	17,24
32 14M 170	43170032	2F	St	32	142,60	139,88	154	100		187	202	32	403	19,92
34 14M 170	43170034	2F	St	34	151,52	148,79	160	100		187	202	32	404	22,72
36 14M 170	43170036	2F	St	36	160,43	157,68	168	120		187	202	32	405	26,07
38 14M 170	43170038	2F	St	38	169,34	166,60	183	135		187	202	32	406	29,71
40 14M 170	43170040	2F	St	40	178,25	175,49	188	140		187	202	32	407	33,00
* 44 14M 170	43170044	2F	St	44	196,08	193,28	211	160		187	202	32	411	
* 48 14M 170	43170048	2F	St	48	213,90	211,11	226	160		187	202	32	412	
* 56 14M 170	43170056	2F	St	56	249,55	246,76	256	160		187	202	32	416	
* 64 14M 170	43170064	2F	St	64	285,21	282,41	296	180		187	202	32	418	
* 72 14M 170	43170072	7	GG	72	320,86	318,06		180	278	187	187	32		
80 14M 170	43170080	7	GG	80	356,51	353,71		180	314	187	187	32		71,00
90 14M 170	43170090	8	GG	90	401,07	398,28		180	358	187	187	38		73,00
112 14M 170	43170112	8	GG	112	499,11	496,32		200	456	187	187	38		95,00
144 14M 170	43170144	8	GG	144	641,71	638,92		220	600	187	187	38		114,00
168 14M 170	43170168	8	GG	168	748,66	745,87		220	706	187	187	38		142,00
* 192 14M 170	43170192	8	GG	192	855,62	852,82		220	813	187	187	38		

* Costruite a richiesta / Manufactured on request