

**Caratteristiche del sistema elastico universale**  
Characteristics of the rubber suspension units

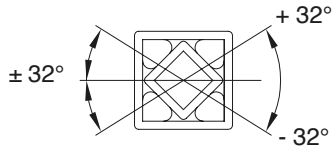

**Ampio angolo d'azione**  
Large operating angle

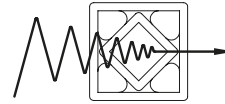

**Riduzione di rumore e vibrazioni**  
Noise and vibration damping

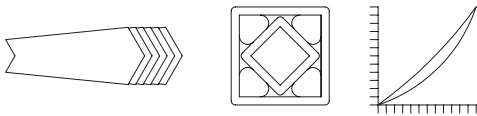

**Progressiva elasticità**  
Progressive spring characteristics

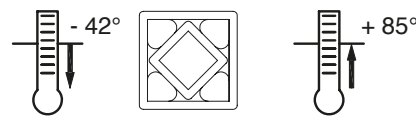

**Resistenza alle temperature**  
Resistant to temperature

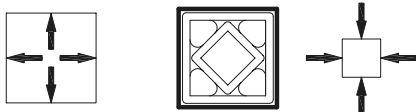

**Sicurezza dell'utilizzo**  
Safe use in any position



**Non necessita di manutenzione**  
Maintenance free

**Istruzioni per il corretto montaggio del tendicatena (TEKS) e dei tendicinghia (TERE)**

Instructions for a proper mounting of the chain tensioner (TEKS) and of the belt tensioner (TERE)

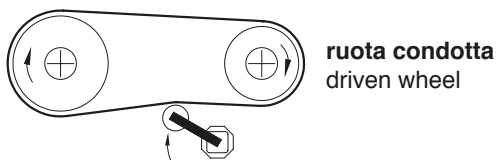

**ruota condotta**  
driven wheel

**Tenditore sul lato lasco**  
Tensioner on the loose side

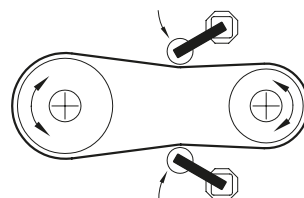

**Con motore reversibile montare 2 tendicatena**  
With reversible engine mount 2 tensioners

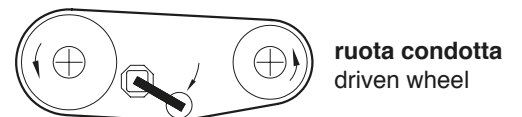

**ruota condotta**  
driven wheel

**Montaggio con trasmissione a cinghia con profilo a V**  
Mounting with belt transmission with V profile

**Caratteristiche della gomma**  
Characteristics of the rubber

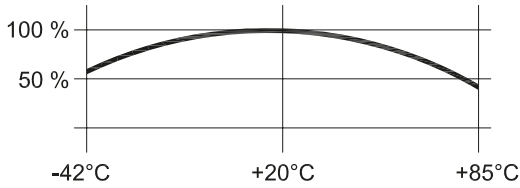

**Temperatura ambiente**  
Room temperature

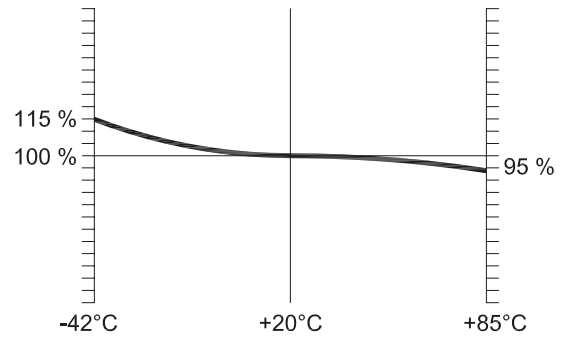

**Temperatura ambiente**  
Room temperature

**Durata in condizioni normali di temperatura ~ 10 anni**  
Temperature influence: service life (under normal conditions) ~ 10 years

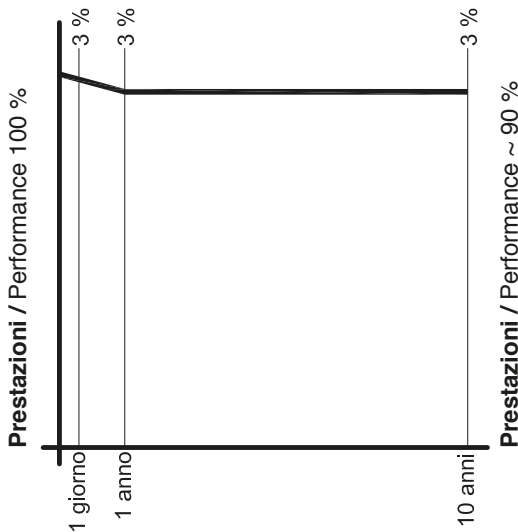

**Deformazioni e assestamento della gomma**  
Could flow and setting

**Influenza della temperatura: coppia di reazione (N/m)**  
Temperature influence: torque reaction (N/m)

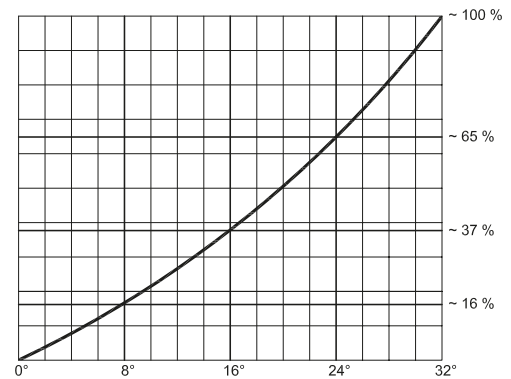

**Determinazione della coppia "in percentuale"**  
Torque determination "in percentage"

**Il grafico è applicabile per tutte le dimensioni dei tipi: LTK-S, LTK-A, LTS, LTA**

This chart is applicable to all type of: LTK-S, LTK-A, LTS, LTA

**Esempio per la determinazione LTS 6-80 con coppia M 215 in Nm a 32° (pag 150)**

Example for determinating LTS 6-80 with torque M 215 with Nm a 32° (page 150)

**Con angolo di 15° = 35% = ~ 75 Nm**

With an angle of 15° = 35% = ~ 75 Nm

**Con angolo di 22° = 56% = ~ 120 Nm**

With an angle of 22° = 56% = ~ 120 Nm

**Con angolo di 28° = 81% = ~ 174 Nm**

With an angle of 28° = 81% = ~ 174 Nm



# TENDICATENA UNIVERSALI TIPO "TEKS" UNIVERSAL CHAIN TENSIONERS TYPE "TEKS"

**RESATEC**  
CERTIFICATA ISO 9001

## SEMPLICI

descrizione	catena	codice	ISO	denti	A	B	Kg.
TEKS 3	3/8" x 7/32"	6020110330	06B1	15	20 ÷ 50	M10	0,60
TEKS 3	1/2" x 5/16"	6020110340	08B1	15	20 ÷ 50	M10	0,65
TEKS 5	5/8" x 3/8"	6020110350	10B1	15	26 ÷ 67	M12	2,32
TEKS 5	3/4" x 7/16"	6020110360	12B1	15	26 ÷ 67	M12	2,55
TEKS 6	1" x 17,02	6020110380	16B1	13	37 ÷ 102	M20	5,00
TEKS 7	1"1/4 x 3/4"	6020110400	20B1	13	39 ÷ 122	M20	8,55
TEKS 7	1"1/2 x 1"	6020110420	24B1	11	39 ÷ 142	M20	8,90

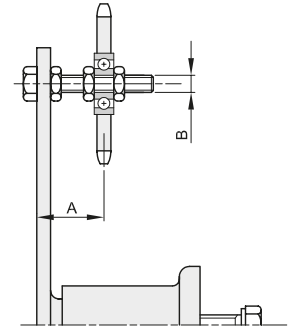

## DOPPI

descrizione	catena	codice	ISO	denti	A	B	Kg.
TEKS 3	3/8" x 7/32"	6020120330	06B2	15	25 ÷ 44	M10	0,65
TEKS 4	1/2" x 5/16"	6020120340	08B2	15	27 ÷ 43	M10	1,15
TEKS 5	5/8" x 3/8"	6020120350	10B2	15	34 ÷ 59	M12	2,55
TEKS 5	3/4" x 7/16"	6020120360	12B2	15	36 ÷ 57	M12	3,00
TEKS 6	1" x 17,02	6020120380	16B2	13	52 ÷ 86	M20	5,80
TEKS 7	1"1/4 x 3/4"	6020120400	20B2	13	57 ÷ 104	M20	10,10
TEKS 7	1"1/2 x 1"	6020120420	24B2	11	63 ÷ 118	M20	10,75

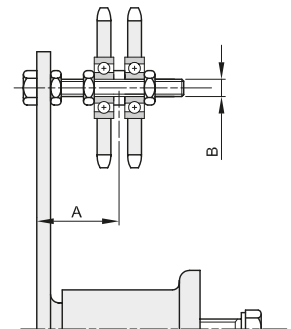

## TRIPLI

descrizione	catena	codice	ISO	denti	A	B	Kg.
TEKS 4	3/8" x 7/32"	6020130330	06B3	15	31 ÷ 39	M10	0,95
TEKS 5	1/2" x 5/16"	6020130340	08B3	15	40 ÷ 53	M12	2,45
TEKS 6	5/8" x 3/8"	6020130350	10B3	15	53 ÷ 85	M20	4,95
TEKS 6	3/4" x 7/16"	6020130360	12B3	15	56 ÷ 83	M20	5,20
TEKS 7	1" x 17,02	6020130380	16B3	13	70 ÷ 70	M20	9,40
TEKS 7	1"1/4 x 3/4"	6020130400	20B3	13	75 ÷ 86	M20	11,70
TEKS 7	1"1/2 x 1"	6020130420	24B3	11	87 ÷ 94	M20	12,70

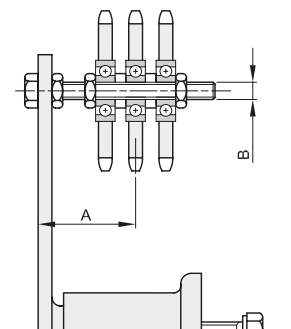



## TENDICATENA UNIVERSALI TIPO "TECRS" UNIVERSAL CHAIN TENSIONERS TYPE "TECRS"



### SEMPLICI

descrizione	catena	codice	ISO	A	B	Kg.
TECRS 2	3/8" x 7/32"	6020210330	06B1	18 ÷ 35	M8	0,30
TECRS 3	1/2" x 5/16"	6020210340	08B1	23 ÷ 45	M10	0,56
TECRS 4	5/8" x 3/8"	6020210350	10B1	24 ÷ 44	M10	0,82
TECRS 5	3/4" x 7/16"	6020210360	12B1	30 ÷ 60	M12	2,17

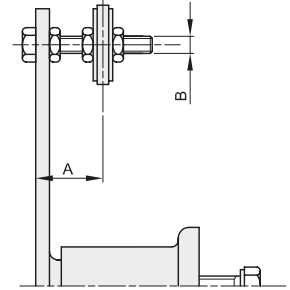

### DOPPI

descrizione	catena	codice	ISO	A	B	Kg.
TECRS 2	3/8" x 7/32"	6020220330	06B2	25 ÷ 30	M8	0,32
TECRS 3	1/2" x 5/16"	6020220340	08B2	30 ÷ 34	M10	0,60
TECRS 4	5/8" x 3/8"	6020220350	10B2	34 ÷ 46	M10	0,90
TECRS 5	3/4" x 7/16"	6020220360	12B2	40 ÷ 52	M12	2,31

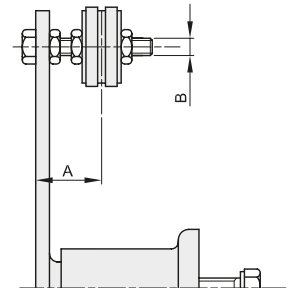

## TENDICINGHIA UNIVERSALI TIPO "TERE" UNIVERSAL BELT TENSIONERS TYPE "TERE"



descrizione	codice	A	B	C	Ø D	E	Kg.
TERE 2	6020300301	61	43	80	30	35	0,32
TERE 3	6020300401	70	56	100	40	45	0,62
TERE 4	6020300402	88	57	100	40	45	0,85
TERE 5	6020300601	122	76	130	60	60	2,34
TERE 6	6020300801	158	109	175	80	90	4,90
TERE 7	6020300802	211	154	220	80	135	8,20

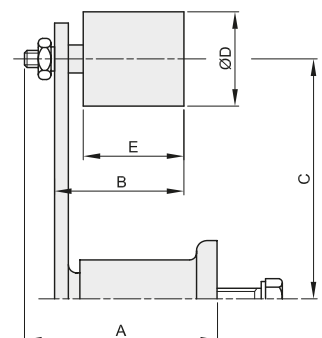



# ELEMENTI TENDITORI UNIVERSALI TIPO "TE" UNIVERSAL TENSIONERS TYPE "TE"

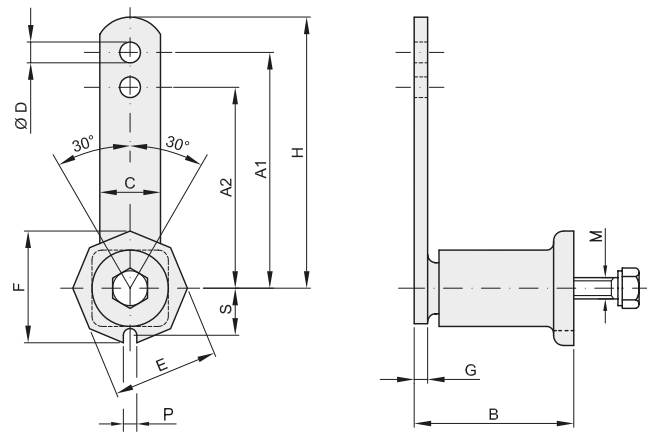

descrizione	codice	A1	A2	B	C	Ø D	E	F	G	H	Forza max in N		M	P	S	Kg.	
											Torque in N	Torque in N					
												A1	A2				
TE 2	6021000020	80	60	52	20	8,5	35	38	5	90	0 - 90	0 - 110	M 6	8	16,5	0,25	
TE 3	6021000030	100	80	63	25	10,5	46	48	5	115	0 - 140	0 - 170	M 8	8,5	19,5	0,45	
TE 4	6021000040	100	80	78	30	10,5	56	60	6	115	0 - 320	0 - 430	M10	8,5	24,5	0,68	
TE 5	6021000050	130	100	108	50	12,5	72	78	8	155	0 - 820	0 - 1050	M12	10,5	34	1,70	
TE 6	6021000060	175	140	145	60	20,5	93	100	10	205	0 - 1500	0 - 1880	M16	12,5	42	3,70	
TE 7	6021000070	220	175	198	70	20,5	106	114	12	255	0 - 2500	0 - 3200	M20	12,5	50	6,50	

descrizione	codice	A1	A2	B	C	Ø D	E	F	G	H	Forza max in N		M	P	S	Kg.	
											Torque in N	Torque in N					
												A1	A2				
TE 2 - INOX	6021000120	80	60	52	20	8,5	35	38	5	90	0 - 90	0 - 110	M 6	8	16,5	0,25	
TE 3 - INOX	6021000130	100	80	63	25	10,5	46	48	5	115	0 - 140	0 - 170	M 8	8,5	19,5	0,45	
TE 4 - INOX	6021000140	100	80	78	30	10,5	56	60	6	115	0 - 320	0 - 430	M10	8,5	24,5	0,68	
TE 5 - INOX	6021000150	130	100	108	50	12,5	72	78	8	155	0 - 820	0 - 1050	M12	10,5	34	1,70	



# PATTINI TENDICATENA TIPO "CRS" CHAINRIDER SET TYPE "CRS"

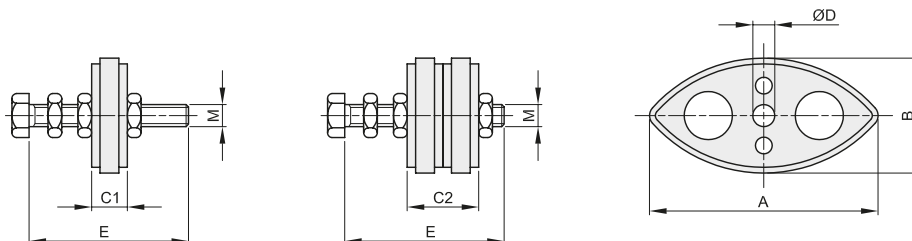

descrizione	catena	codice	ISO	A	B	C1	C2	Ø D	M	E	semplice Kg.	doppio Kg.
CRS 3/8"	3/8" x 7/32"	6023330000	06B	74	40	10,2	20,4	8	M8	45	0,05	0,07
CRS 1/2"	1/2" x 5/16"	6023340000	08B	96	50	13,9	27,8	10	M10	60	0,11	0,15
CRS 5/8"	5/8" x 3/8"	6023350000	10B	125	55	16,5	33,0	10	M10	60	0,14	0,22
CRS 3/4"	3/4" x 7/16"	6023360000	12B	147	80	19,5	39,0	12	M12	80	0,22	0,36



## PIGNONI TENDICATENA TIPO "KS" - DIN 8187 SPROCKETS WHEELS TYPE "KS" - DIN 8187

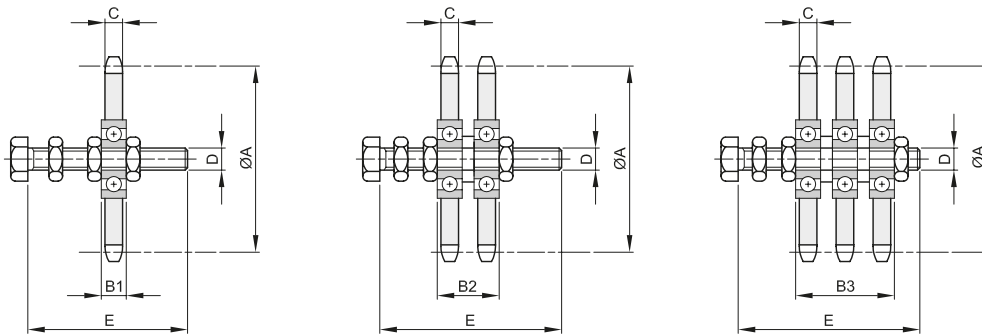

descrizione	codice	ISO	denti	Ø A	B1	B2	B3	C	D	E	semplice Kg.	doppio Kg.	triplo Kg.
KS 3/8" x 7/32"	6022330151	06B-1-2-3	15	45,81	9	19,2	29,4	5,7	M10	60	0,15	0,20	0,25
KS 1/2" x 5/16"	6022340151	08B-1-2	15	61,08	9	22,9		7,2	M10	60	0,20	0,35	
KS 1/2" x 5/16"	6022340152	08B-1-2-3	15	61,08	12	26,0	40,0	7,2	M12	80	0,23	0,45	0,50
KS 5/8" x 3/8"	6022350151	10B-1-2-3	15	76,36	12	28,6	45,2	9,1	M12	80	0,37	0,60	0,95
KS 5/8" x 3/8"	6022350152	10B-1-2-3	15	76,36	15	31,5	48,2	9,1	M20	120	0,70	1,00	1,25
KS 3/4" x 7/16"	6022360151	12B-1-2	15	91,63	12	31,5		11,5	M12	80	0,60	1,05	
KS 3/4" x 7/16"	6022360152	12B-1-2-3	15	91,63	15	34,5	54,0	11,5	M20	120	0,90	1,35	1,50
KS 1" x 17,02	6022380131	16B-1-2-3	13	106,14	15	46,9	78,8	16,2	M20	120	1,30	2,10	2,90
KS 1 1/4" x 3/4"	6022400131	20B-1-2-3	13	132,67	15	51,5	88,0	18,5	M20	140	2,05	3,60	5,20
KS 1 1/2" x 1"	6022420111	24B-1-2-3	11	135,23	15	63,4	111,8	24,1	M20	160	2,40	4,25	6,20



## RULLI TENDICINGHIA TIPO "RE" ROLLERSET TYPE "RE"

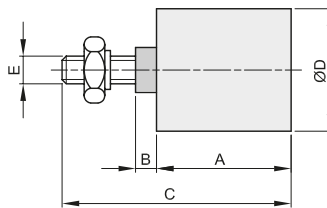

descrizione	codice	A	B	C	Ø D	E	Kg.
RE 2	6023000301	35	3	51	30	M8	0,07
RE 3	6023000401	45	6	67	40	M10	0,17
RE 4	6023000401	45	6	67	40	M10	0,17
RE 5	6023000601	60	7,5	89	60	M12	0,39
RE 6	6023000801	90	9	127	80	M20	1,20
RE 7	6023000802	135	7	167	80	M20	1,70



## ELEMENTI OSCILLANTI TIPO "OM" OSCILLANTING MOUNTING TYPE "OM"

**RESATEC**  
CERTIFICATA ISO 9001

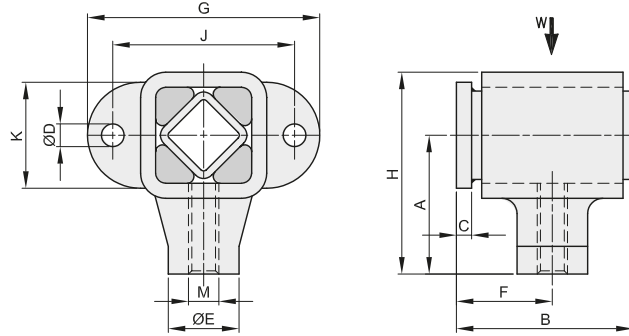

descrizione	codice	A	B	C	Ø D	E	F	G	H	J	K	M	W carico max in N	Fr Freq. max in min -1	Kg.
OM 4 R	6024000041	40	61	5	9	24	33	82	58	60	30	M12 R	190	1250	0,28
OM 4 L	6024000042	40	61	5	9	24	33	82	58	60	30	M12 L	190	1250	0,28
OM 5 R	6024000051	55	75	6	11	30	41	108	81	80	45	M16 R	380	780	0,58
OM 5 L	6024000052	55	75	6	11	30	41	108	81	80	45	M16 L	380	780	0,58
OM 6 R	6024000061	80	98	8	13	40	53	130	115	100	60	M20 R	780	760	1,45
OM 6 L	6024000062	80	98	8	13	40	53	130	115	100	60	M20 L	780	760	1,45
OM 7 R	6024000071	90	118	8	17	50	63	170	135	130	70	M24 R	1550	750	2,54
OM 7 L	6024000072	90	118	8	17	50	63	170	135	130	70	M24 L	1550	750	2,54
OM 8 R	6024000081	100	140	10	17	60	75	180	147	140	80	M36 R	2400	580	6,05
OM 8 L	6024000082	100	140	10	17	60	75	180	147	140	80	M36 L	2400	580	6,05



## TESTE DI BIELLA TIPO "DH" CRANKDRIVE UNIT TYPE "DH"

**RESATEC**  
CERTIFICATA ISO 9001

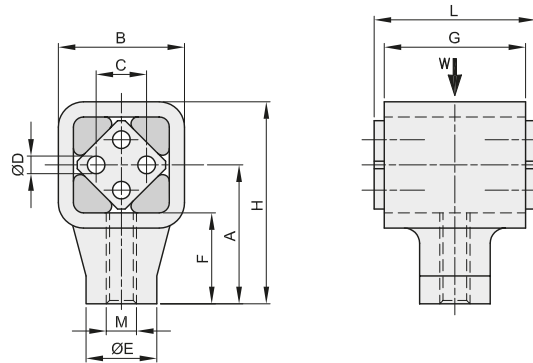

descrizione	codice	A	B	C	Ø D	E	F	G	H	L	M	W forza accel. in N	ne Vel. di rotaz. in min -1	Kg.
DH 4-50 R	6025004501	40	36	12	6	24	25	50	58	55	M12 R	380	1250	0,20
DH 4-50 L	6025004502	40	36	12	6	24	25	50	58	55	M12 L	380	1250	0,20
DH 5-60 R	6025005601	55	52	20	8	30	35	60	81	65	M16 R	960	1200	0,52
DH 5-60 L	6025005602	55	52	20	8	30	35	60	81	65	M16 L	960	1200	0,52
DH 6-80 R	6025006801	80	72	25	10	40	52	80	115	90	M20 R	1900	780	1,48
DH 6-80 L	6025006802	80	72	25	10	40	52	80	115	90	M20 L	1900	780	1,48
DH 7-100 R	6025071001	90	90	35	12	50	55	100	135	110	M24 R	3400	750	2,65
DH 7-100 L	6025071002	90	90	35	12	50	55	100	135	110	M24 L	3400	750	2,65
DH 8-120 R	6025081201	100	94	40	M12x30	60	64	120	147	130	M36 R	5800	580	6,30
DH 8-120 L	6025081202	100	94	40	M12x30	60	64	120	147	130	M36 L	5800	580	6,30
DH 9-200 R	6025092001	120	120	45	M16x25	80	75	200	180	210	M42 R	11500	330	17,70
DH 9-200 L	6025092002	120	120	45	M16x25	80	75	200	180	210	M42 L	11500	330	17,70
DH 9-300 R	6025093001	120	120	45	M16x25	80	75	300	180	310	M42 R	17500	300	26,50
DH 9-300 L	6025093002	120	120	45	M16x25	80	75	300	180	310	M42 L	17500	300	26,50





## ELEMENTI ELASTICI TIPO "LTK-S" RUBBER SUSPENSION UNIT TYPE "LTK-S"

**RESATEC**  
CERTIFICATA ISO 9001

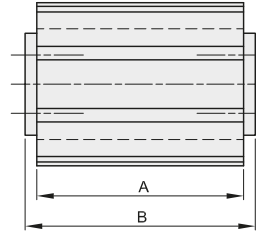
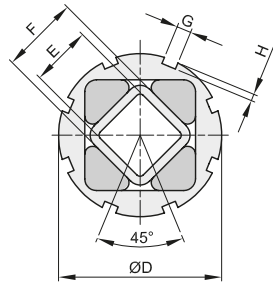

descrizione	codice	Coppia M in Nm a 32° Torque M in Nm at 32°	A	B	Ø D	E	F	G	H	Kg.
LTK-S 5-40	6029005040	56	40	45	62	22	27	6	3	0,30
LTK-S 5-60	6029005060	85	60	65	62	22	27	6	3	0,40
LTK-S 5-100	6029005100	140	100	105	62	22	27	6	3	0,65
LTK-S 6-60	6029006060	160	60	70	80	30	38	7	3,5	0,70
LTK-S 6-80	6029006080	215	80	90	80	30	38	7	3,5	0,90
LTK-S 6-120	6029006120	320	120	130	80	30	38	7	3,5	1,30



## ELEMENTI ELASTICI TIPO "LTK-A" RUBBER SUSPENSION UNIT TYPE "LTK-A"

**RESATEC**  
CERTIFICATA ISO 9001

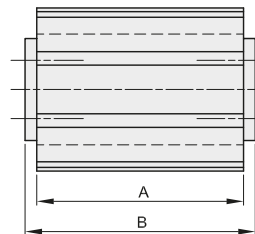
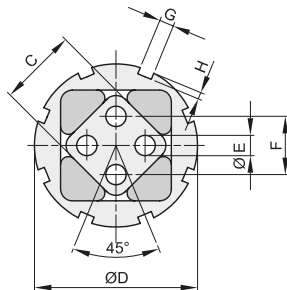

descrizione	codice	Coppia M in Nm a 32° Torque M in Nm at 32°	A	B	C	Ø D	Ø E	F	G	H	Kg.
LTK-A 5-40	6030005040	56	40	45	27	62	8	20	6	3	0,25
LTK-A 5-60	6030005060	85	60	65	27	62	8	20	6	3	0,35
LTK-A 5-100	6030005100	140	100	105	27	62	8	20	6	3	0,60
LTK-A 6-60	6030006060	160	60	70	38	80	10	25	7	3,5	0,60
LTK-A 6-80	6030006080	215	80	90	38	80	10	25	7	3,5	0,80
LTK-A 6-120	6030006120	320	120	130	38	80	10	25	7	3,5	1,20



# ELEMENTI ELASTICI TIPO "LTS" RUBBER SUSPENSION UNIT TYPE "LTS"

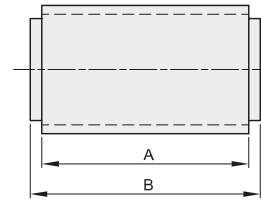
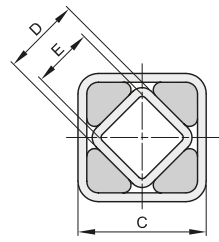

descrizione	codice	Coppia M in Nm a 32° Torque M in Nm at 32°	A	B	C	D	E	Kg.
LTS 3-25	6027003025	8	25	30	27	15	11	0,08
LTS 3-40	6027003040	13	40	45	27	15	11	0,13
LTS 3-60	6027003060	19	60	65	27	15	11	0,19
LTS 4-30	6027004030	20	30	35	32	18	12	0,13
LTS 4-50	6027004050	34	50	55	32	18	12	0,22
LTS 4-80	6027004080	54	80	85	32	18	12	0,33
LTS 5-40	6027005040	56	40	45	45	27	22	0,27
LTS 5-60	6027005060	85	60	65	45	27	22	0,40
LTS 5-100	6027005100	140	100	105	45	27	22	0,66
LTS 6-60	6027006060	160	60	70	60	38	30	0,68
LTS 6-80	6027006080	215	80	90	60	38	30	0,90
LTS 6-120	6027006120	320	120	130	60	38	30	1,35
LTS 7-80	6027007080	315	80	90	72	45	35	1,20
LTS 7-100	6027007100	390	100	110	72	45	35	1,46
LTS 7-150	6027007150	580	150	160	72	45	35	2,16
LTS 8-120	6027008120	720	120	130	80	50	40	2,20
LTS 8-200	6027008200	1300	200	210	80	50	40	3,50
LTS 8-300	6027008300	2000	300	310	80	50	40	5,30



## ELEMENTI ELASTICI TIPO "LTA" RUBBER SUSPENSION UNIT TYPE "LTA"

**RESATEC**  
CERTIFICATA ISO 9001

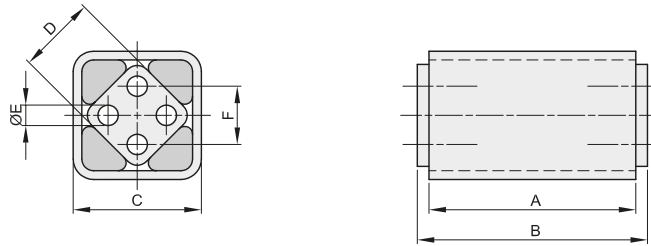

descrizione	codice	Coppia M in Nm a 32° Torque M in Nm at 32°	A	B	C	D	Ø E	F	Kg.
LTA 4-30	6028004030	20	30	35	32	18	6	12	0,10
LTA 4-50	6028004050	34	50	55	32	18	6	12	0,15
LTA 4-80	6028004080	54	80	85	32	18	6	12	0,26
LTA 5-40	6028005040	56	40	45	45	27	8	20	0,26
LTA 5-60	6028005060	85	60	65	45	27	8	20	0,37
LTA 5-100	6028005100	140	100	105	45	27	8	20	0,62
LTA 6-60	6028006060	160	60	70	60	38	10	25	0,61
LTA 6-80	6028006080	215	80	90	60	38	10	25	0,80
LTA 6-120	6028006120	320	120	130	60	38	10	25	1,15
LTA 7-80	6028007080	315	80	90	72	45	12	35	1,01
LTA 7-100	6028007100	390	100	110	72	45	12	35	3,00
LTA 7-150	6028007150	580	150	160	72	45	12	35	4,45
LTA 8-120	6028008120	760	120	130	80	50	M12x40	40	1,85
LTA 8-200	6028008200	1370	200	210	80	50	M12x40	40	3,02
LTA 8-300	6028008300	2050	300	310	80	50	M12x40	40	4,48



## ELEMENTI OSCILLANTI TIPO "HC" OSCILLANTING-MOUNTINGS TYPE "HC"

**RESATEC**  
CERTIFICATA ISO 9001

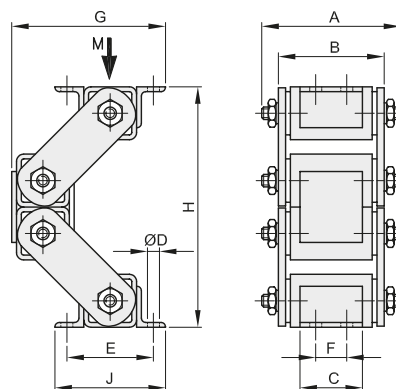

descrizione	codice	A	B	C	Ø D	E	F	G	G max	H	H min	J	CARICO LAOD M in N	Kg.
HC 6	6023500006	138	117	65	13	100	40	180	205	290	190	120	500 - 1500	6,90
HC 7	6023500007	168	142	80	13	115	48	201	225	335	235	135	1100 - 3200	13,50
HC 8	6023500008	195	164	100	17	130	60	224	260	360	250	160	2400 - 7000	20,50



## SUPPORTI TIPO "MA" MOUNTING SUPPORT TYPE "MA"

**RESATEC**  
CERTIFICATA ISO 9001

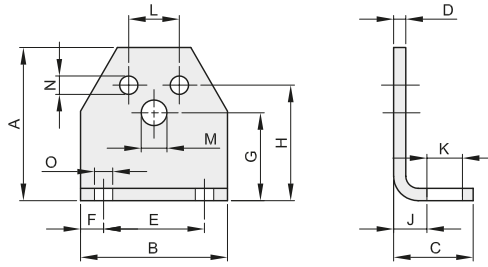

descrizione	codice	adatto a tipo		A	B	C	D	E	F	G	H	J	K	L	M	N	O	Kg.
		TE...	LT...															
MA 2	6031000002	2	3	46	50	30	4	30	10	27	35	12	13	10	6,5	5,5	7	0,09
MA 3	6031000003	3	4	58	60	32	6	40	10	34	44	14	13	12	8,5	6,5	7	0,19
MA 4	6031000004	4	5	75	70	38	6	50	10	45	55	16	16	20	10,5	8,5	9,5	0,30
MA 5	6031000005	5	6	98	90	52	8	65	12,5	58	75	21	22	25	12,5	10,5	11,5	0,70
MA 6	6031000006	6	7	116	110	55	8	80	15	66	85	21	24	35	16,5	12,5	14	0,90
MA 7	6031000007	7	8	140	140	66	10	100	20	80	110	26	30	40	20,5	12,5	18	1,80



## STAFFE TIPO "CK" MOUNTING CLAMP TYPE "CK"

**RESATEC**  
CERTIFICATA ISO 9001

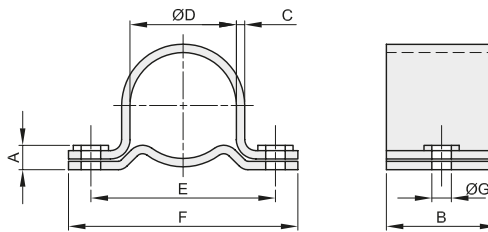

descrizione	codice	A	B	C	Ø D	E	F	Ø G	Kg.
CK 5	6032000005	10	40	3	62	92	125	10,5	0,30
CK 6	6032000006	11	40	3	80	115	150	12,5	0,45



## STAFFE TIPO "MS" MOUNTING CLAMP TYPE "MS"

**RESATEC**  
CERTIFICATA ISO 9001

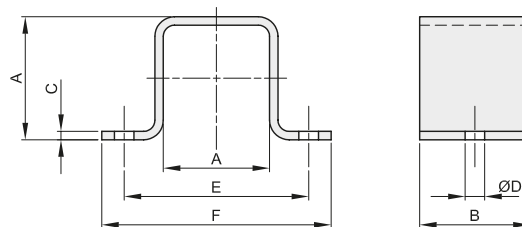

descrizione	codice	A	B	C	Ø D	E	F	Kg.
MS 3	6033000003	27	25	2	6,5	50	65	0,04
MS 4	6033000004	32	30	3	8,5	60	80	0,09
MS 5	6033000005	45	35	3	10,5	80	105	0,16
MS 6	6033000006	60	40	5	12,5	100	125	0,29
MS 7	6033000007	72	45	5	12,5	115	145	0,45
MS 8	6033000008	80	50	6	17	130	170	0,68